

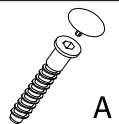







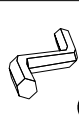

NAROŽNIK GÓRNY
SKRINKA HORNÁ ROHOVÁ
ECKHÄNGESCHRANK
WALL UNIT - CORNER
HAUT ANGLE

											
10	8	1	1	2	20	10	2	4	2	2	4

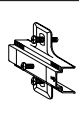

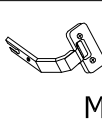
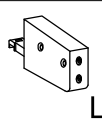
Pakoval:

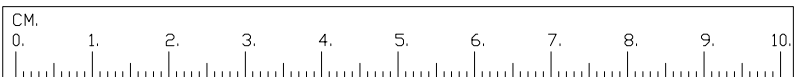
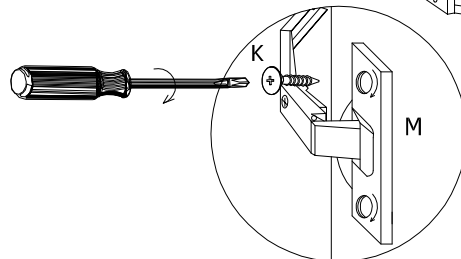
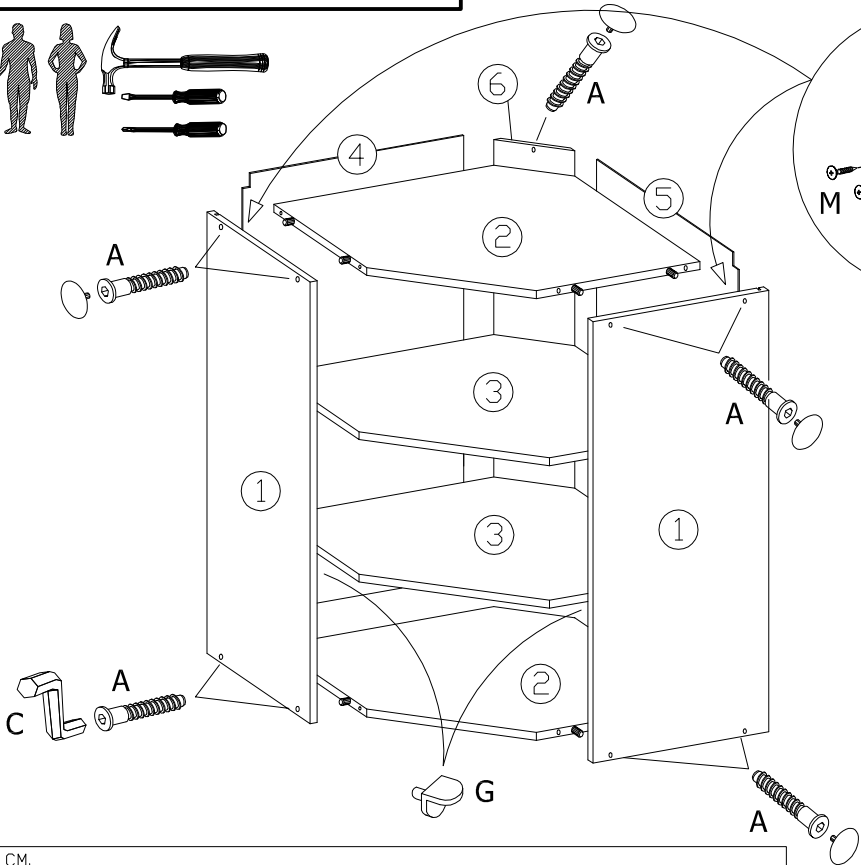
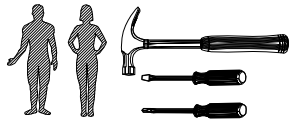
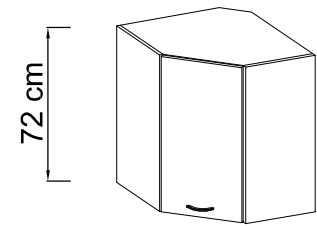
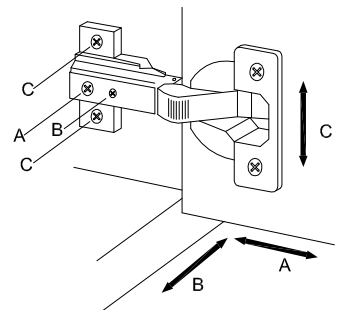
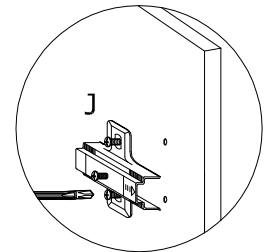
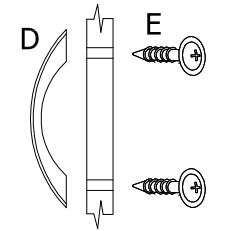
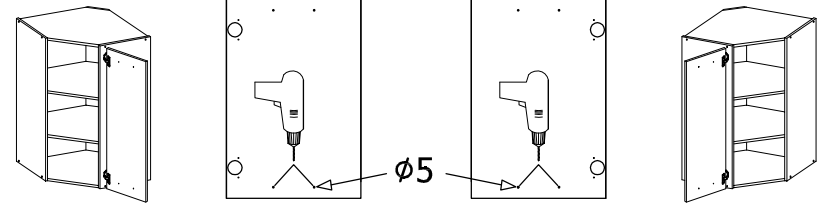
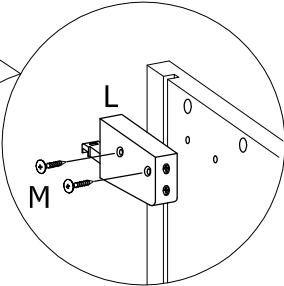
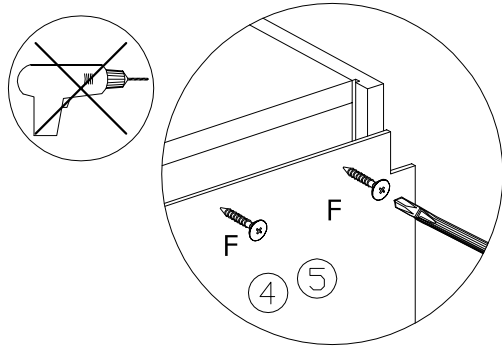
Szanowny kliencie.
 W razie reklamacji jakościowej lub ilościowej proszę podać nr pakującego oraz nr elementu.
 Achtung: Bei eventuellen Beanstandungen, bitten wir Sie die Nr. des packers sowie die, des fehlenden bzw. beschädigten Teiles unbedingt anzugeben.
 Dragi kupci.
 Prilikom eventualne reklamacije morate obavezno navesti broj pečata koji je na paketu i broj dijelova koji nedostaju ili su oštećeni u paketu. Jedino u tom slučaju možemo prihvatiti Vašu reklamaciju kao valjanu. Unaprijed Vam zahvaljuje Vaš.
 Dear Customer.
 We regret to inform you, that in time complaint please give No packer and No missing and spoil element.